

KBG-SD series

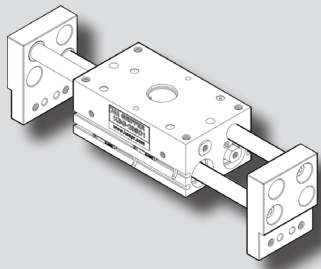

KBG-20SD

Features

- Dual piston type with rack & pinion principle
- Increased efficiency design with piston at the bottom
- Sensor is applicable with embedded neodymium magnet on the piston
- Improved hardness and lubrication with no magnet on the guide rack
- With pin hole for body and jaw positioning
- SD1 type is built-in wearing to improve durability and it is strong against buckling load by increasing the guide rod diameter.

How to order

KBG - 20 SD 1 + A93 x 2

① ② ③ ④ ⑤ ⑥

① Series

KBG	Block gripper
-----	---------------

② Bore size

12	2x Ø12	25	2x Ø25
16	2x Ø16	32	2x Ø32
20	2x Ø20	40	2x Ø40

③ Structure type

SD	SD type
----	---------

④ Stroke type

Nil	Standard
1	Long stroke

⑤ Auto switch

Reed A/S		Solid state A/S		Notes
Order name	Model	Order name	Model	
A93(V)	D-A93(V)K	F-9□(V)	D-F9□(V)K	□ = N, P, B
A93N	D-A93KN	F-9□(V)	D-F9□(V)K	
A93(V)S	D-A93(V)K-S	F-9□(V)	D-F9□(V)K	

※ Refer to Auto Switch Catalogue for more information.

⑥ Quantity of sensor parts

#	Quantity of sensor
---	--------------------

Specifications

	KBG-12	KBG-16		KBG-20	KBG-25	KBG-32	KBG-40	
	SD1	SD	SD1	SD1	SD1	SD1	SD	SD1
Fluid	Compressed air							
Operating Pressure	1~7kgf/cm ² (0.1~0.7MPa)							
Ambient Temperature	0~60℃							
Stroke(mm)	40	30	60	80	100	120	100	160
Port size	M5					Rc(PT) 1/8		
Air consumption(CC/Cycle)	6.8	9.0	18.1	32.2	75.6	144.8	188.5	301.6
Max. gripping point(mm)	25	60	40	45	70	75	100	90
Frequency(Cycle/min)	30			24			20	
Repeat Accuracy(mm)	±0.2 (After initial 100 operation) / ±0.5 (After 1 million operation)							
Gripping force(N) ※ P = Mpa, L=mm	133.9xP 1+0.007xL	230.9xP 1+0.007xL	240.9xP 1+0.005xL	323.9xP 1+0.004xL	613.8xP 1+0.003xL	966.6xP 1+0.003xL	1460.4xP 1+0.003xL	1518.4xP 1+0.002xL
Weight(kg)	0.37	0.57	0.84	1.59	2.53	4.02	5.54	7.3

Dimensions

KBG-12SD1

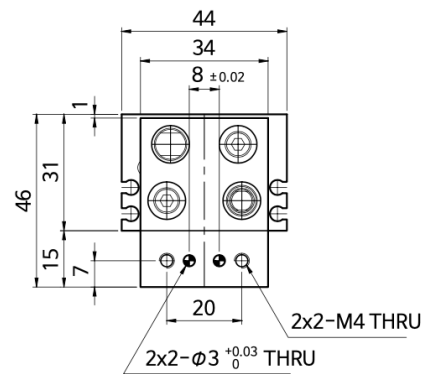
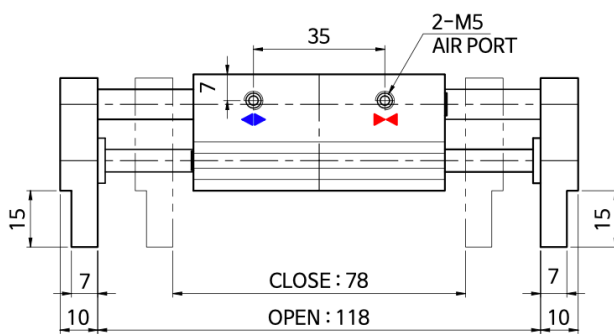
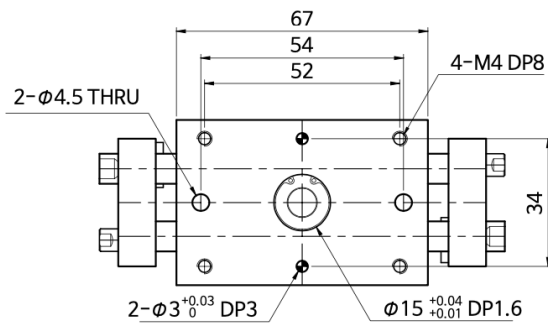
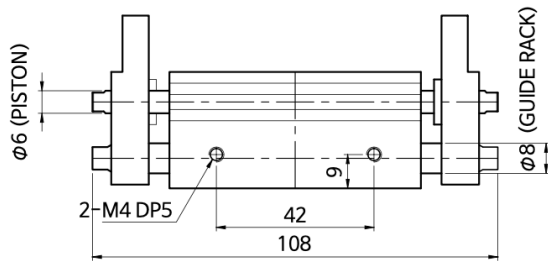

Dimensions

KBG-16SD

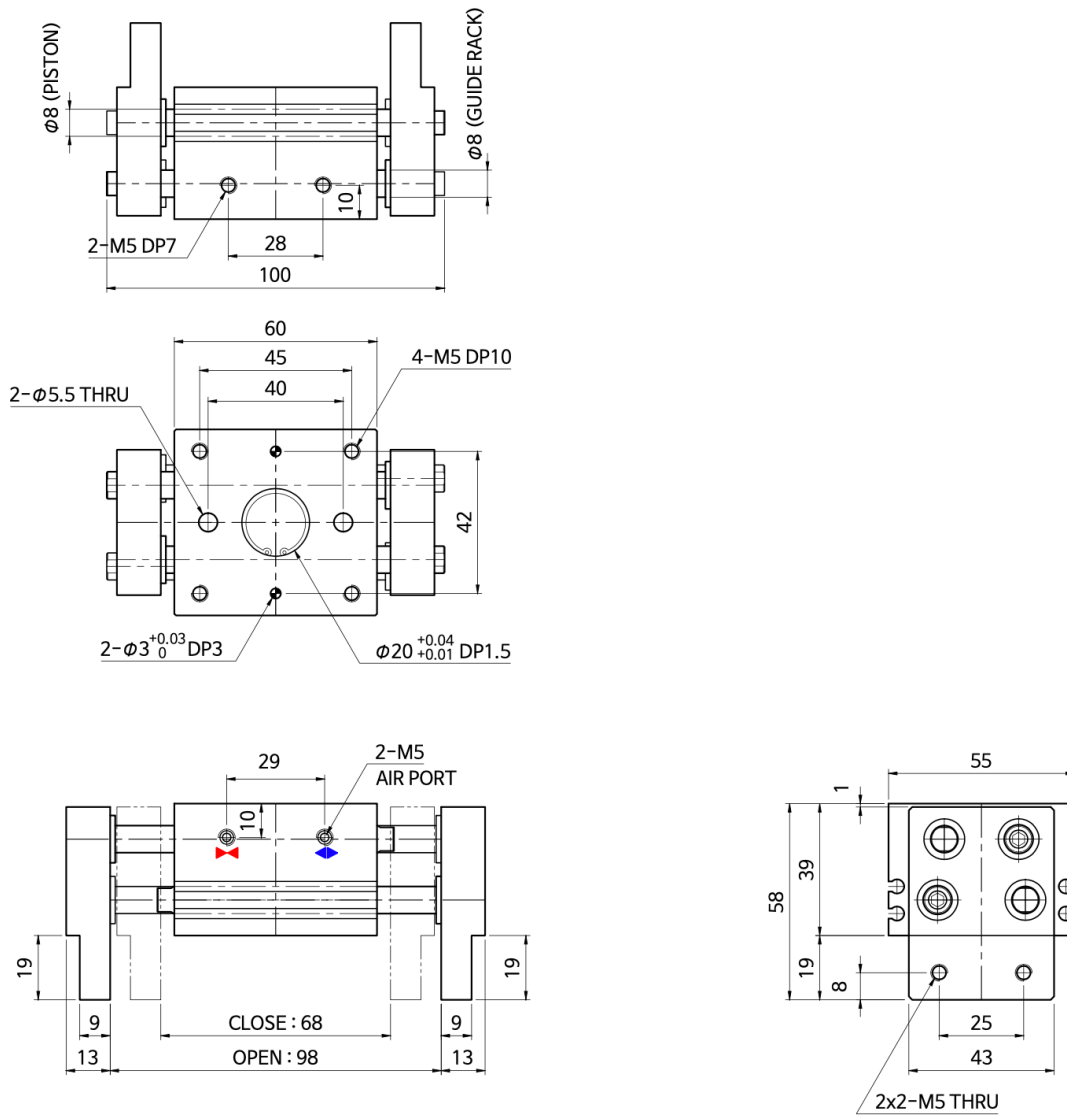

Dimensions

KBG-16SD1

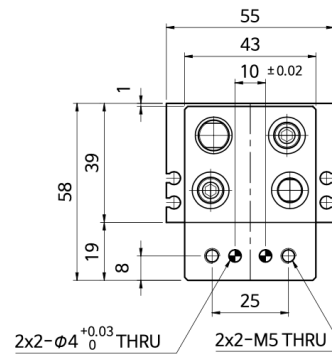
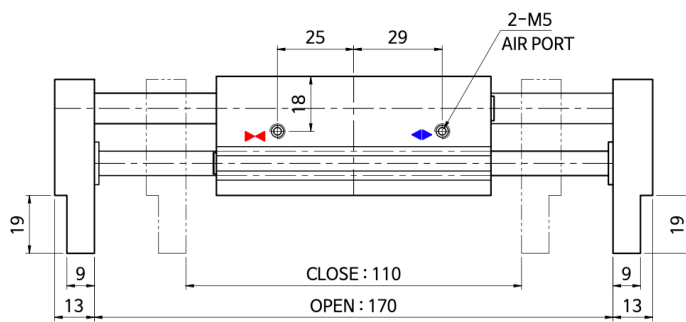
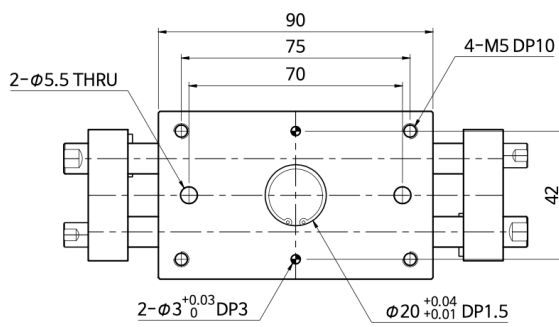
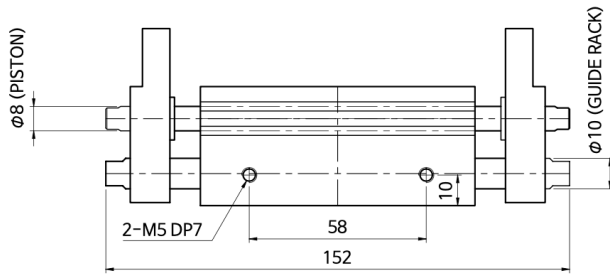

Dimensions

KBG-20SD1

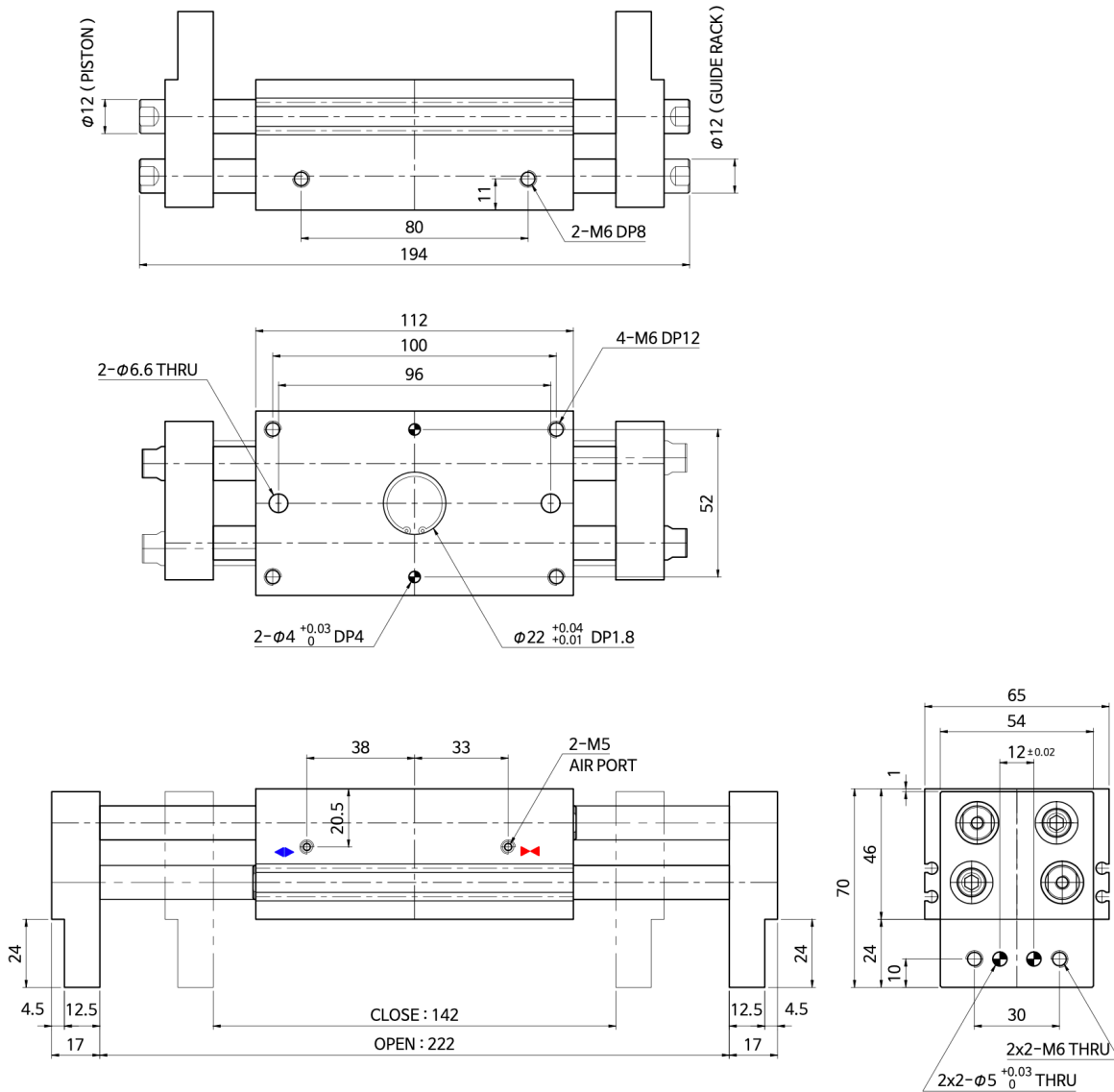

Dimensions

KBG-25SD1

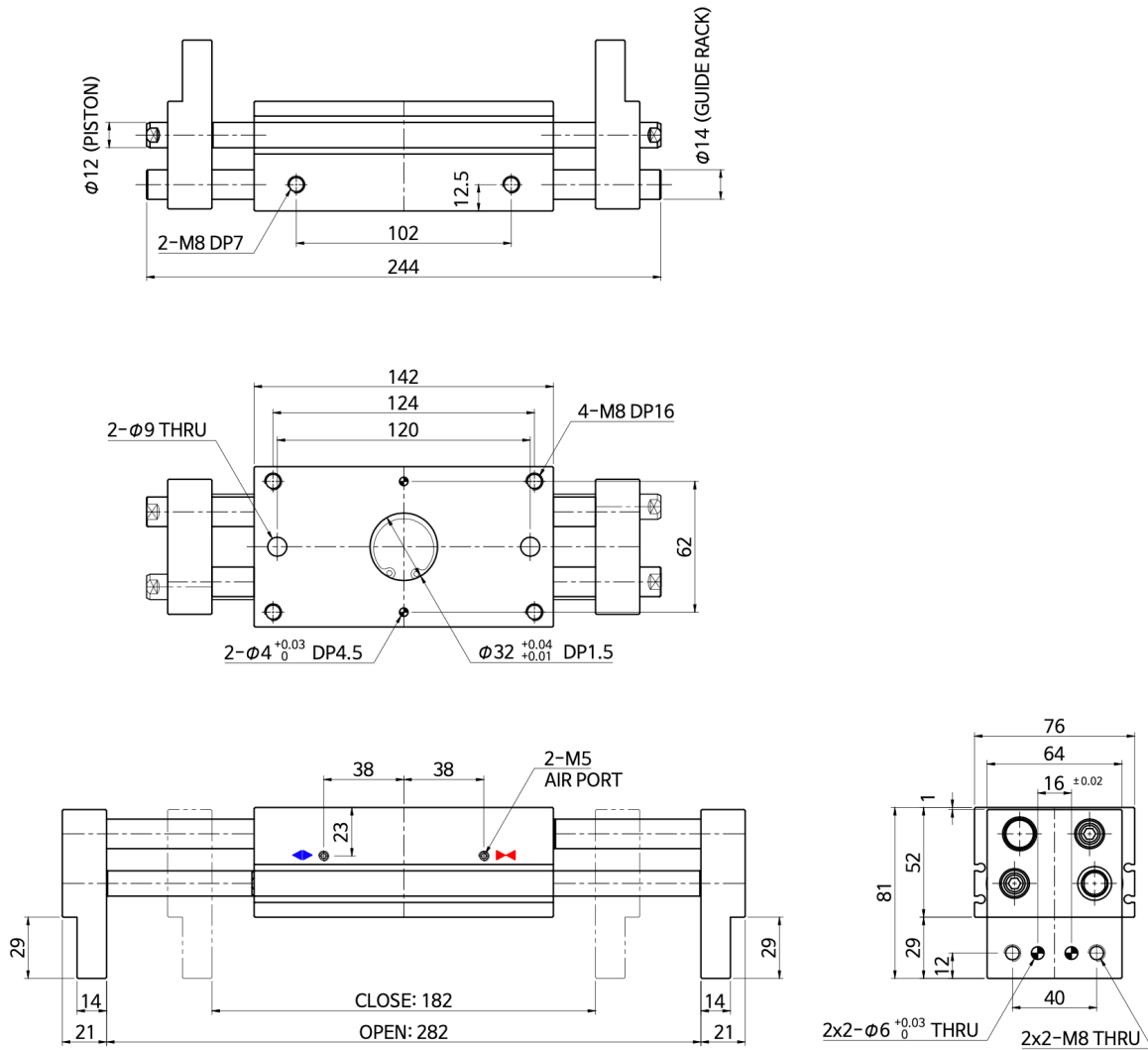

Dimensions

KBG-32SD1

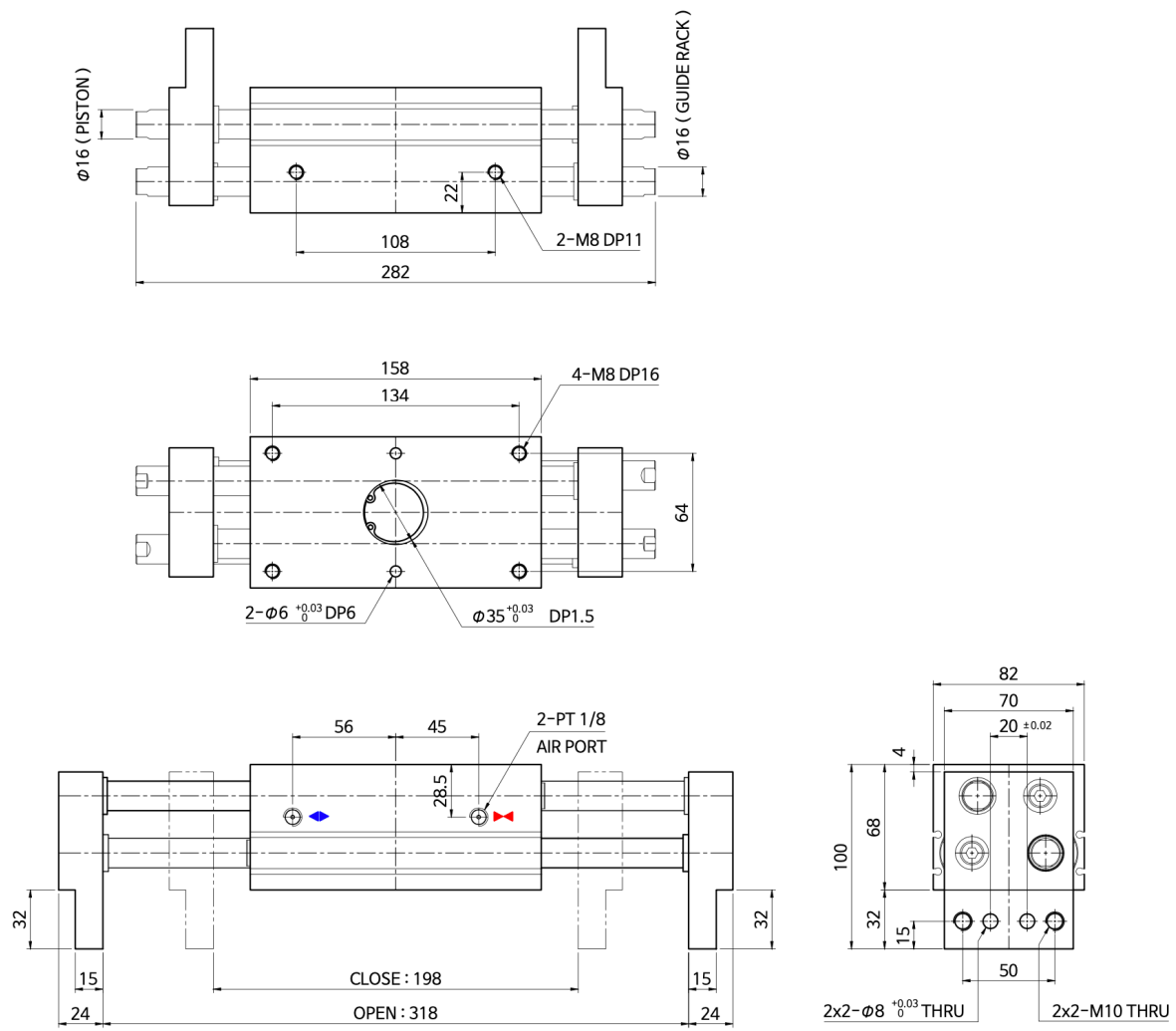

Dimensions

KBG-40SD

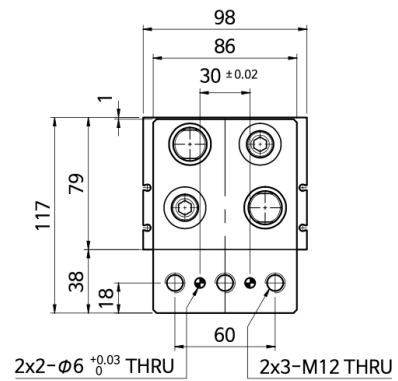
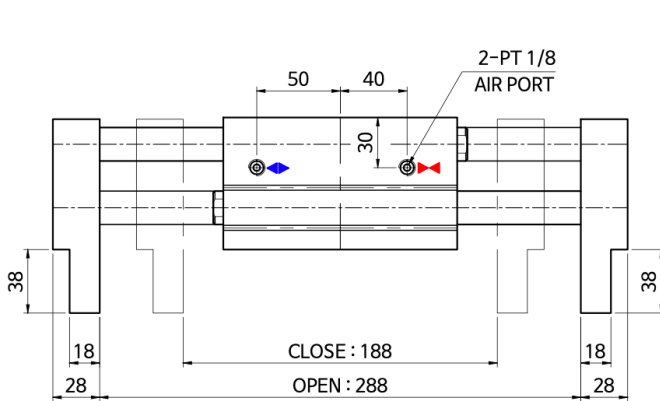
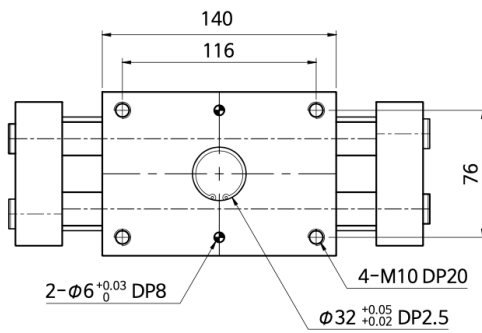
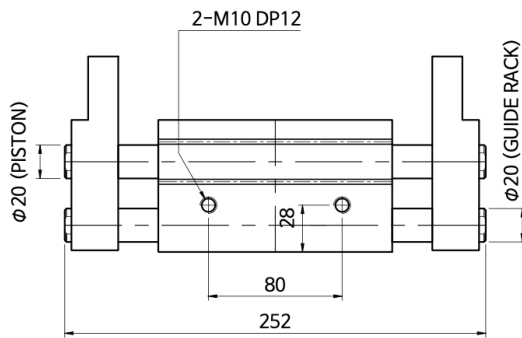

Dimensions

KBG-40SD1

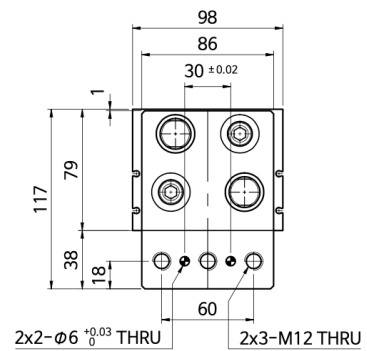
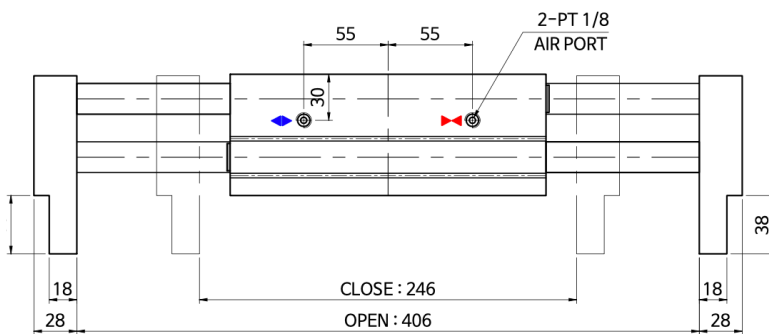
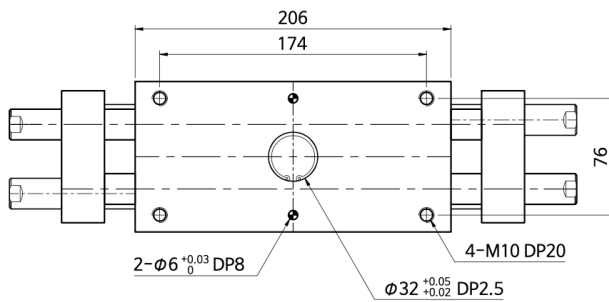
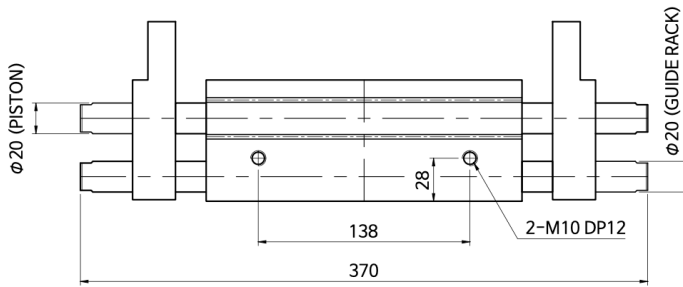

Effective gripping force [N](●=0.5 [Mpa], ◆=0.7 [Mpa])

(Condition of use)

1. (Fixed or slow moving): Graph x 1/5
2. (General deceleration and acceleration such as linear motion): Graph x 1/10
3. (Rapid deceleration and acceleration such as robot attachment or rotation): Graph x 1/20

◆ KBG-12SD1

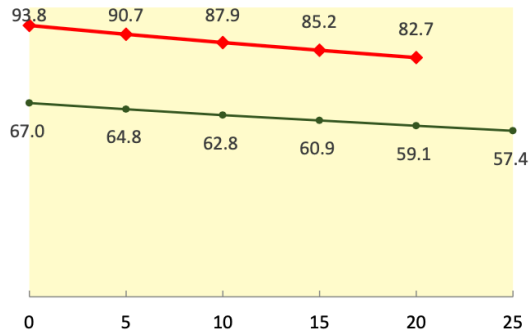

◆ KBG-16SD

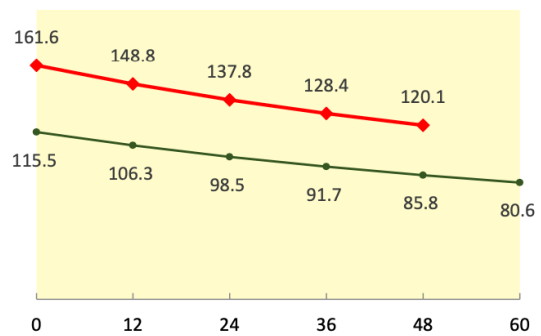

◆ KBG-16SD1

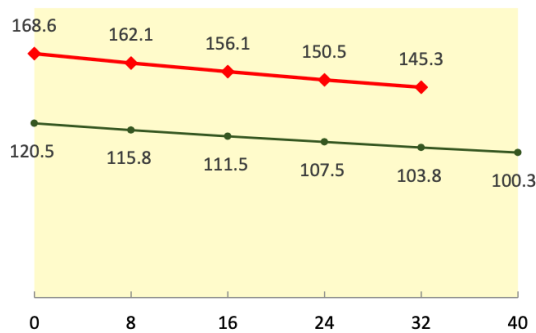

◆ KBG-20SD1

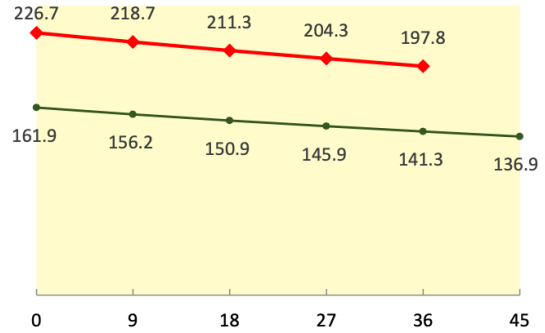

◆ KBG-25SD1

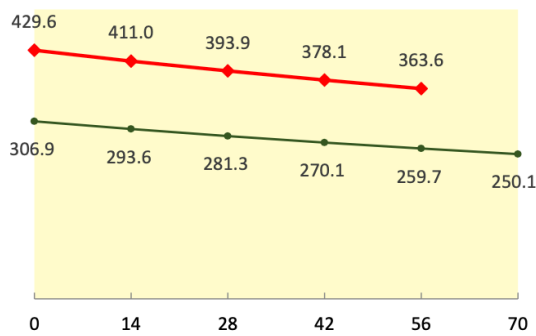

◆ KBG-32SD1

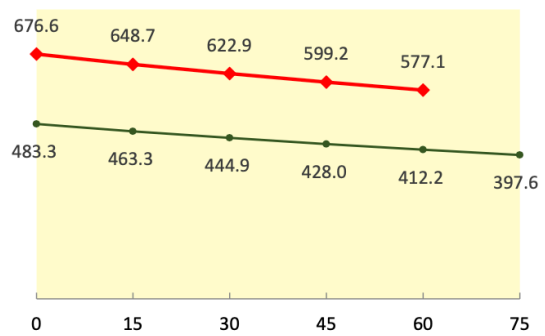

◆ KBG-40SD

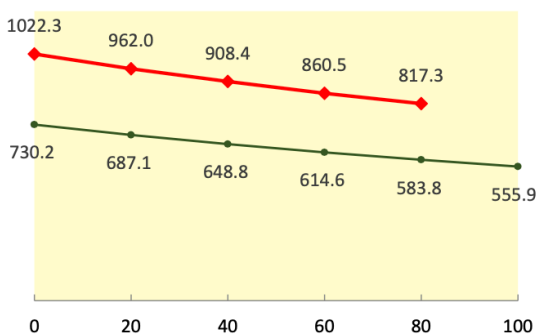

◆ KBG-40SD1

